

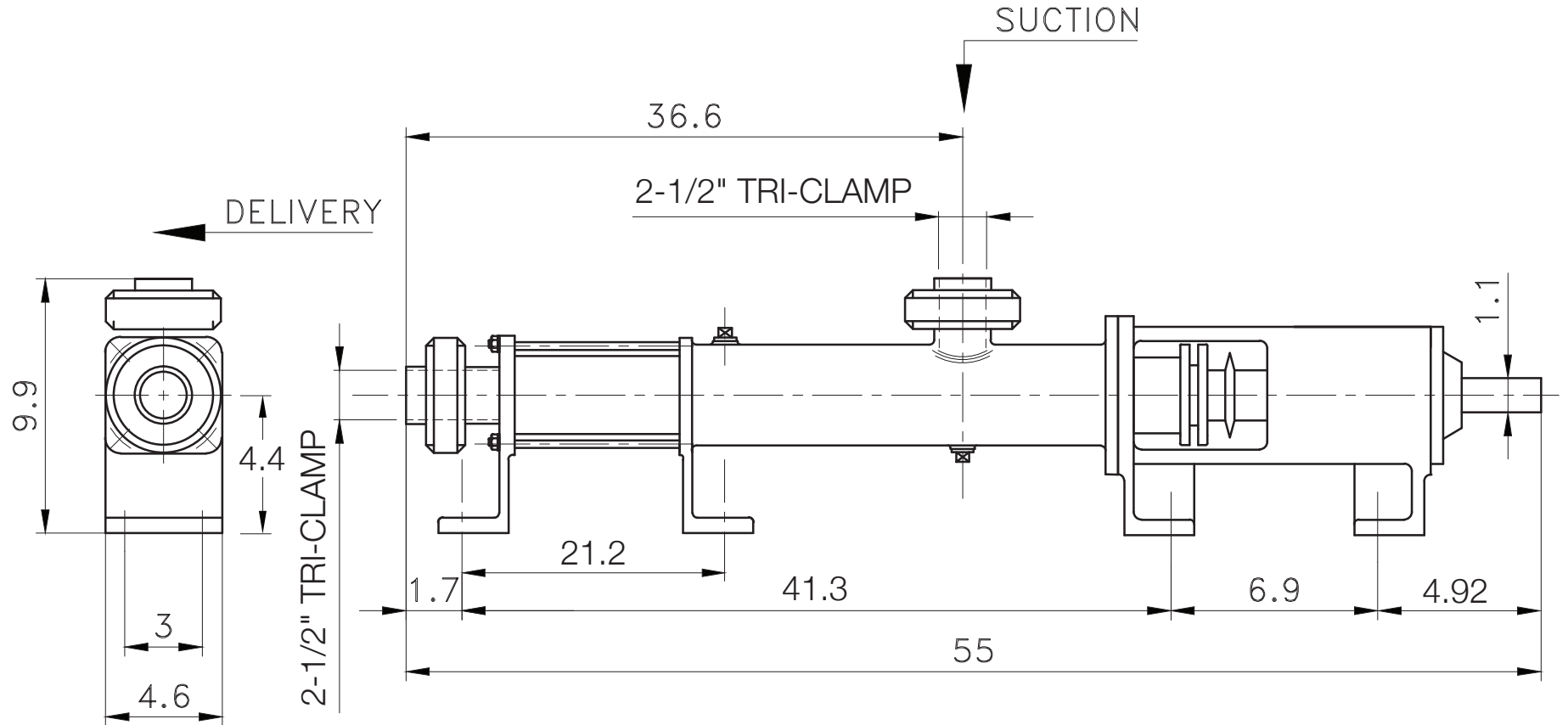

FREEDOM SERIES - 2FFL45

Sanitary Progressive Cavity Pump

Dimensional Drawings



Net weight

≈ lbs.

103.62

ALL DIMN: Inches

2 Stage Pump

P: 847.640.7867 F: 847.640.7855
2525 Clearbrook Drive Arlington Heights, IL 60005

www.libertyprocess.com