

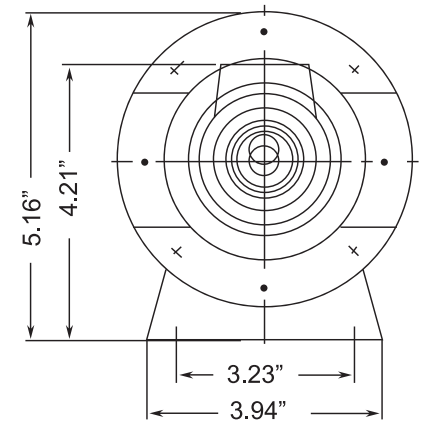

ADPL SERIES - ADPL 1.50.3

Progressive Cavity Pump

Dimensional Drawings

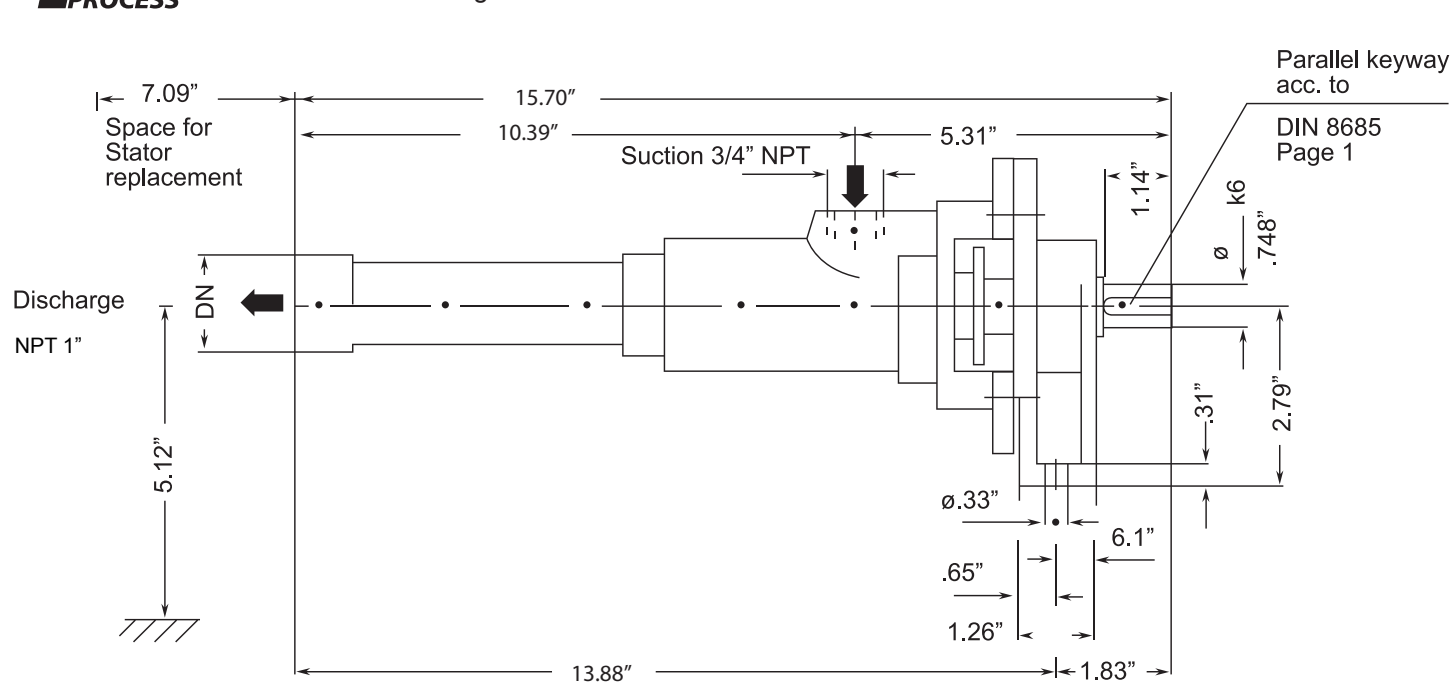

Possible port positions looking from drive end

1 = Standard

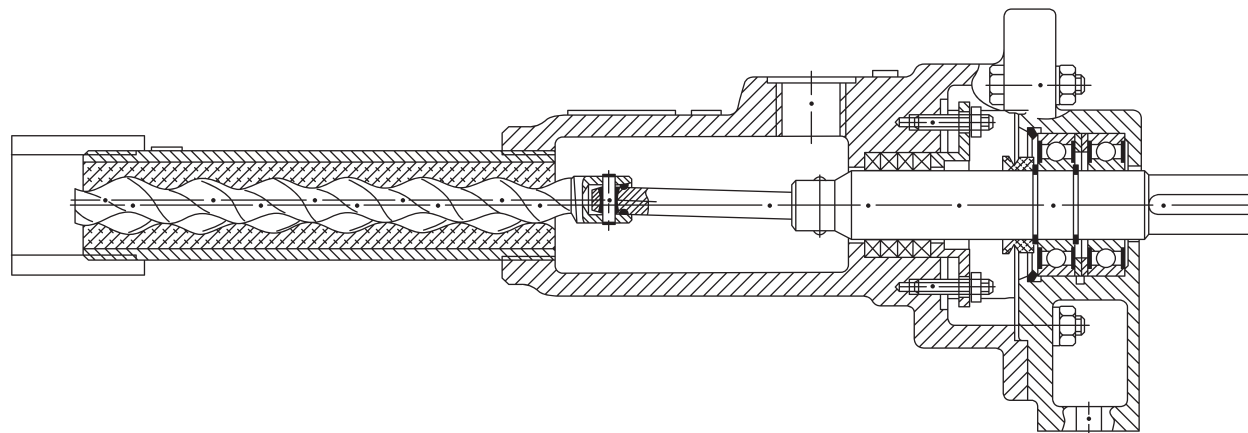
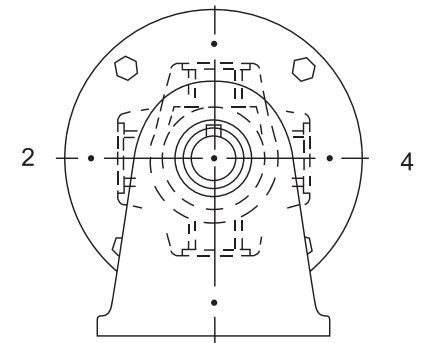

	Net weight
	≈ lbs.
Inches	8.4

3 Stage Pump

P: 847.640.7867 F: 847.640.7855
2525 Clearbrook Drive Arlington Heights, IL 60005

www.libertyprocess.com