

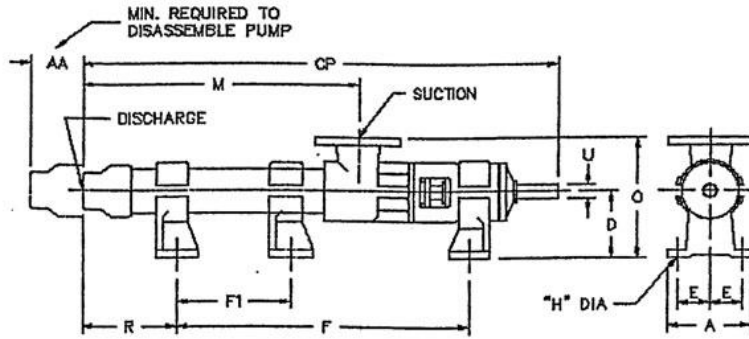

Liberty Pump Series – Dimension Sheet



Standard Pump Dimensions

Model	AA	CP	A	D	E	F	F1	H	M	O	R	U	Suct. Size	Disc. Size	Approx. Lbs.
2ML1	6.50	17.31	4.00	3.25	1.56	8.50	-	.37	7.62	5.88	4.56	.62	1.00	.75	22
3ML1	6.50	19.12	4.00	3.25	1.56	9.62	-	.37	9.44	5.88	5.25	.62	1.00	.75	24
6ML1	6.50	24.69	4.00	3.25	1.56	15.75	-	.37	15.00	5.88	4.69	.62	1.00	.75	30
1LL2	6.50	17.25	4.00	3.25	1.56	8.50	-	.37	7.56	5.88	4.50	.62	1.00	.75	22
2LL2	6.50	20.75	4.00	3.25	1.56	10.50	-	.37	11.06	5.88	6.00	.62	1.00	.75	25
3LL2	6.50	24.37	4.00	3.25	1.56	12.00	-	.37	14.69	5.88	8.12	.62	1.00	.75	31
6ML2	8.37	39.12	5.75	4.12	2.12	25.50	14.00	.44	26.50	7.31	7.94	.75	1.50	.75	55
1LL3	8.37	23.00	5.37	4.12	2.12	11.50	-	.44	10.37	7.31	5.81	.75	1.50	1.25	47
2LL3	8.37	28.31	5.37	4.12	2.12	13.00	-	.44	15.69	7.31	9.62	.75	1.50	1.25	51
3LL3	8.37	33.62	5.37	4.12	2.12	16.50	-	.44	21.00	7.31	11.44	.75	1.50	1.25	55
6ML3	11.37	54.62	7.00	5.50	2.75	37.50	22.00	.56	37.75	9.88	10.12	.94	2.50	1.25	105
1LL4	11.37	30.37	7.00	5.50	2.75	15.75	-	.56	13.50	9.88	7.62	.94	2.50	2.00	85
2LL4	11.37	37.44	7.00	5.50	2.75	22.00	-	.56	20.56	9.88	8.44	.94	2.50	2.00	91
3LL4	11.37	44.50	7.00	5.50	2.75	22.75	-	.56	27.62	9.88	14.75	.94	2.50	2.00	97
6ML4	14.25	71.25	8.62	6.25	3.50	45.00	25.00	.69	49.94	11.25	17.69	1.12	3.00	2.50	171
1LL6	14.25	39.37	8.62	6.25	3.50	20.00	-	.69	18.06	11.25	10.81	1.12	3.00	2.50	141
2LL6	14.25	50.00	8.62	6.25	3.50	26.00	-	.69	28.69	11.25	15.44	1.12	3.00	2.50	159
3LL6	14.25	60.62	8.62	6.25	3.50	38.00	18.00	.69	39.31	11.25	14.06	1.12	3.00	2.50	192
1LL8	18.37	46.31	11.50	8.00	4.50	27.00	-	.88	20.50	14.00	10.06	1.37	4.00	4.00	303
2LL8	18.37	58.75	11.50	8.00	4.50	32.00	-	.88	32.94	14.00	17.50	1.37	4.00	4.00	322
3LL8	18.37	71.12	11.50	8.00	4.50	49.00	24.00	.88	45.31	14.00	12.88	1.37	4.00	4.00	372
1LL10	31.88	53.62	11.50	9.75	4.50	30.00	-	.88	22.37	16.69	10.12	1.88	6.00	5.00	412
2LL10	31.88	64.00	11.50	9.75	4.50	35.50	-	.88	32.75	16.69	15.00	1.88	6.00	5.00	460
3LL10	31.88	74.37	11.50	9.75	4.50	48.00	18.00	.88	43.12	16.69	12.88	1.88	6.00	5.00	545
1LL10H	31.88	59.00	11.50	9.75	4.50	30.00	-	.88	27.75	16.69	15.50	1.88	6.00	5.00	424
2LL10H	31.88	74.37	11.50	9.75	4.50	48.00	18.00	.88	43.12	16.69	12.88	1.88	6.00	5.00	545
1LL12	37.75	70.19	14.50	12.50	6.31	37.50	-	1.00	31.44	21.00	14.69	2.25	8.00	6.00	880
2LL12	37.75	85.88	14.50	12.50	6.31	55.50	20.50	1.00	47.50	21.00	12.37	2.25	8.00	6.00	1075
3LL12	37.75	101.44	14.50	12.50	6.31	69.00	27.00	1.00	62.69	21.00	14.44	2.25	8.00	6.00	1200
1LL12H	37.75	78.00	14.50	12.50	6.31	42.00	-	1.00	39.25	21.00	18.00	2.25	8.00	6.00	945
2LL12H	37.75	101.44	14.50	12.50	6.31	69.00	27.00	1.00	62.69	21.00	14.44	2.25	8.00	6.00	1205

*All listed dimensions in inches